

Easylink-LE Installation instruction

• Description

The easylink connection system is a simple, fast and reliable set of connection kits developed for heating cables. There is no wire stripping needed because the insulation displacement connector makes the electrical connection.

The connection kit shall be designed to be installed above the pipe insulation and shall not be immersed in the water.

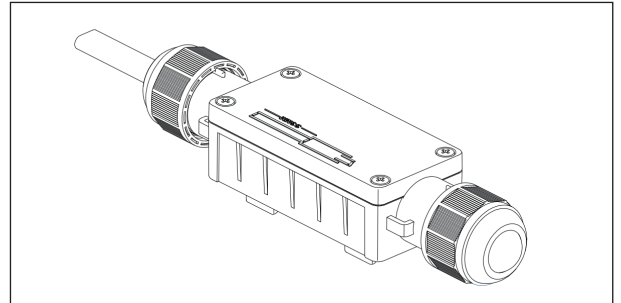

Warning

This component is an electrical device that must be installed correctly to ensure proper operation and to prevent shock or fire. Read these important warnings and carefully follow all the installation instructions.

- To minimize the danger of fire from sustained electrical arcing if the heating cable is damaged or improperly installed, and to Comply with the requirements of approval testing lab and national electrical codes, ground-fault equipment protection must be used. Arcing may not be stopped by conventional circuit breakers.
- The bus wires will be short if they contact each other. Keep bus wires separated.
- Keep components and heating cable ends dry before and during installation.
- The black heating cable core is conductive and can short. It must be properly insulated and kept dry.
- Leave these instructions to the end user for reference and future use.

• Tools

Utility knife Wire cutters Screw driver

• Materials required for installation

Content	Quantity	Description
A	1	Easylink-LE
B	1	Pipe mounting bracket
C	2	Steel belt

• Installation step

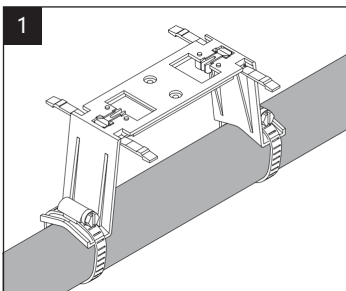

1. Fix the bracket on the pipe line with steel belt
Note: do not install the connector at the place where water is completely invaded

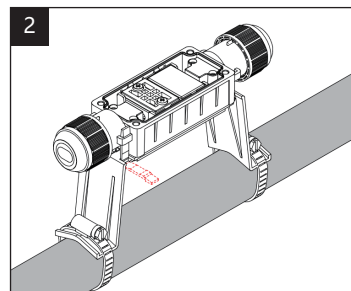

2. Align and insert the four clips of the mounting bracket with the four holes of the quick connector.
Note: installation direction of quick connector

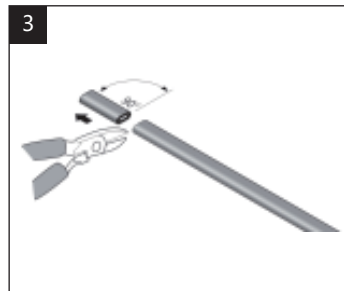

3. Cut off the cable according to the length required for installation.
Note: the cable cutting section shall be flat and tidy

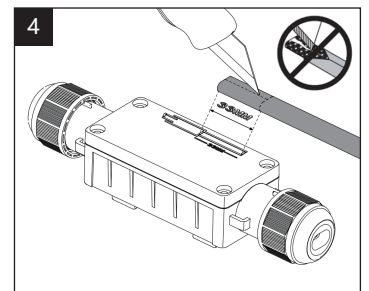

4. Cut the outerjacket from the middle at 33mm away from the cutting section with an utility knife, and remove the outerjacket.

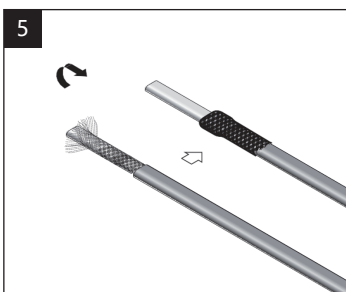

5.1 Heating cable
Pull exposed braid back and tidy it.

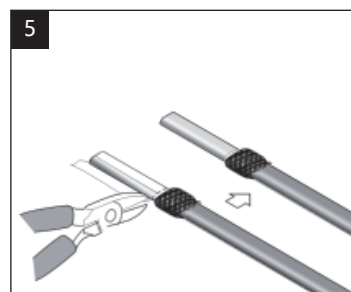

5.2 Heating cable which have aluminum foil layer
Pull exposed braid back and tidy it., and cut the aluminum foil layer.

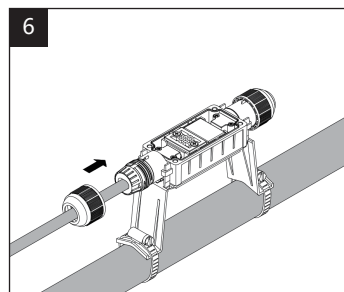

6. Insert the prepared heating cable end into the connector through the elastic cap and push until the heating cable is fully inserted.
Note: the flat direction of the cable must be consistent with the direction of the seal. The Easylink connector is designed to be installed only once. The heating cable cannot be removed once installed.

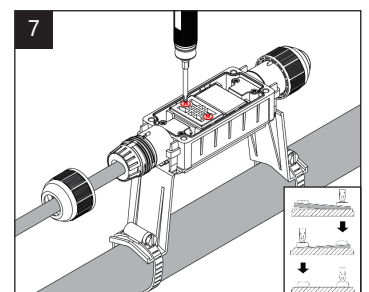

7. Tighten the two screws on the cover plate of the connector alternately to ensure the screw is locked.
Note: there is a fire hazard. Loose screws may cause heating and sparking. Please ensure that the screws are locked.

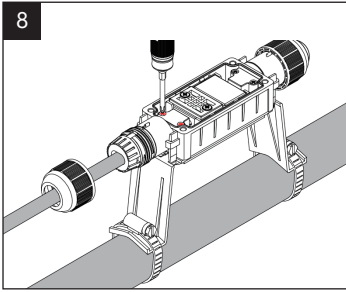

8. Tighten the two screws on the fixed cable block alternately to ensure the screws are locked.

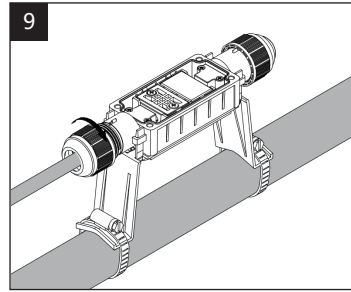

9. Tighten the elastic cap

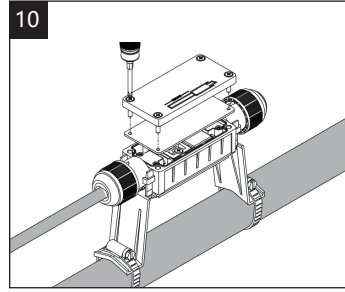

10. After the cable installation is completed, cover the connector cover plate and tighten the four screws alternately to ensure that the sealing ring is compressed.

• Troubleshooting guide

Problem description	Solution
Heating cable cannot be inserted into connector	Check the following: <ol style="list-style-type: none"> 1. The length from the end to the cutting point is 33mm 2. The exposed braid shall be flat and attached to the outerjacket 3. Connecting screws is loosed
Heating cable cannot be removed	The Easylink connection kits are designed to be installed only once, the heating cable cannot be removed once installed.
The prepared heating cable does not work after connected with Easylink connector.	<ol style="list-style-type: none"> 1. Check the power 2. Check the screws to ensure screws are fully tightened 3. Please replace it once failed