

1) Installation

The 2XTC is rated NEMA4X/IP66 and suitable for outdoor installation. The controller should be located at a convenient height for temperature adjustment and out of high traffic areas to minimize the possibility of physical damage. Where possible the controller should be mounted out of direct sunlight to provide maximum visibility for display and indicating lights. Controller operating temperature -40°F (-40°C) to 113°F (45°C)

2) General Wiring Details

To connect heaters, power and signals it is necessary to remove the clear cover of the enclosure remove the brass thumb knob to allow the hinged plate to be raised. For connection details see wiring diagrams on page 3.

3) Heater Lead Routing

Heater connections are routed into the controller using NEMA4X/IP66 cord grips provided. Heater electrical connections are made using fully insulated quick connect terminals for 1/4" tabs supplied on the heater or by the installer.

4) Power Connection

The most common controller configuration includes a cord grip for incoming power that accepts power cords diameters of 0.197-0.472" (5-12 mm). The suitability of flexible cord shall be evaluated by the installer/end user. When desired, or required by code, remove the cord grip and replace with a conduit fitting rated NEMA4X/IP66.

5) Signal Connections

The most common controller configuration includes cord grip for incoming power that accepts power cords to 0.197-0.472" (5-12 mm). The suitability of flexible cord shall be evaluated by the installer. When desired, or required by code remove the cord grip and replace with conduit fitting listed for NEMA4X/ IP66.

6) Controller Cover

To Secure the controller cover tighten all 6 screws to a maximum tightening torque of 10 in-lb. (120 N-cm).

7) Controller Mounting Dimensions

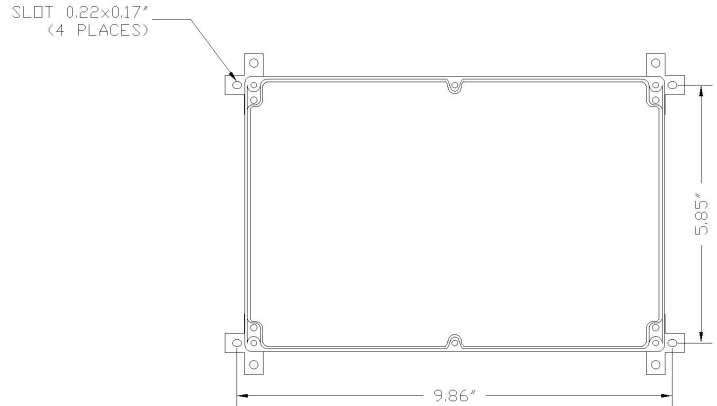

8) Sensor Location

The temperature sensor designated as "PCS" inside the control package must be located as per the figure below and installed on the tank surface using aluminum tape.

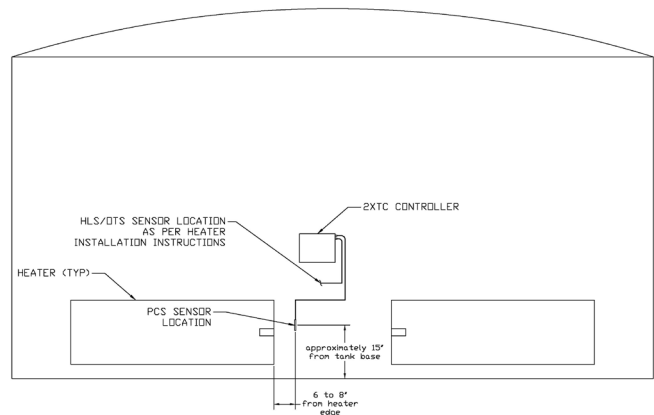

The temperature sensor that is designated "HLS" must be located as detailed in the specific heater installation instructions referred to as HLS or OTS [Over Temperature Sensor]. Correct location of the HLS sensor is critical to safe heating system operation.

Secure the temperature sensor and heater leads to the tank surface using 4" long strips of aluminum tape. Excess lead should be coiled neatly under the control package and protected.

9) Heater Connection

For heaters having the same voltage rating as the power supply complete heater connections as shown. The controller can be used on voltages from 100 to 277 VAC however the heaters used must match the supply voltage. **Failure to correctly match the heaters to the supply voltage can result in damage to the heated surface, the heaters, and/or 2XTC controller.**

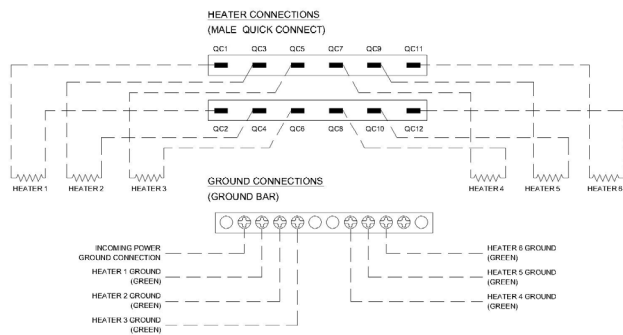

Connect the black lead and the white leads on each heater using fully insulated quick connect terminals. Black heater leads should be connected to the odd numbered tabs and white leads to the even numbered tabs. The green (ground) leads must be connected to the grounding bar as per wiring diagram. **Maximum current draw for any one (1) pair of heater terminals must not exceed 20 Amps.**

10) Power Supply Requirements

The required customer supply to the controller is 100-277 VAC, 50/60HZ depending on the heaters being used. **Supply voltage must match the heater design voltage to prevent damage to the heaters or surface being heated.** The controller has a maximum current of 30 Amps and is labeled to reflect the maximum rating of the controller. The incoming power supply should be sized to fit the specific heating system supplied.

SIGNAL CONNECTIONS (TERMINAL BLOCKS)

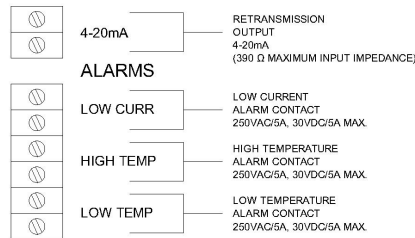

POWER CONNECTION (TERMINAL BLOCKS)

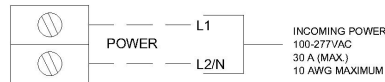

RTD CONNECTIONS (TERMINAL BLOCKS)

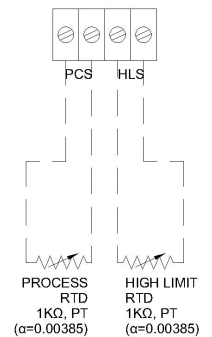

Incoming power terminal blocks accept 10 AWG maximum wire size. Maximum torque for the incoming power terminal blocks is 9.0 in-lb., **DO NOT OVERTIGHTEN.**

11) General Information

The type 2XTC controller has two operating temperature settings. Process temp is the desired maintenance temperature and the high limit removes power from the system if the high limit is reached. The heating system is energized when the process temperature drops below the set point. The heating system stays energized until the process temperature exceeds the set point. The controller shuts off the heating system if a heater temperature exceeds the high limit temperature setting. This protects the tank and/or product from over temperature caused by upset conditions, such as low liquid level.

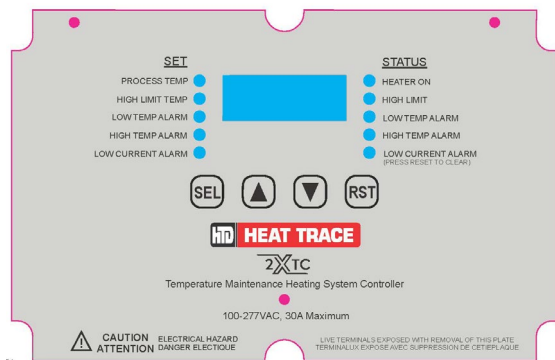

Values under the “SET” notation are values set by the user and also display process values. Indication under STATUS shows heating system operation and alarm status.

12) Main Menu Settings

The 2XTC has 5 control and alarm settings listed under the “SET” heading:

- Process Temperature (PROCESS TEMP)
- High Limit Temperature (HIGH LIMIT TEMP)
- Low Temperature Alarm (LOW TEMP ALARM)
- High Temperature Alarm (HIGH TEMP ALARM)
- Low Current Alarm (LOW CURRENT ALARM)

The values can be seen and adjusted using the keys on the hinged plate assembly. The controller defaults to displaying the process temperature indicated by the light next to “PROCESS TEMP” illuminated. When the light is solidly lit the display is showing the process temperature.

Process Temperature Setting

The process set value should be adjusted to the desired process temperature. Standard system designs are limited to a maximum maintain temperature of 100°F. Contact HTD Heat Trace for applications with process settings above 100°F.

High Limit Temperature Setting

The high limit temperature set value protects the tank, tank liner or product from high heater temperatures. If the heating pad reaches the over temperature setting the heating system is shut off to protect the tank or heat sensitive component.

Incorrect high limit temperature settings may result in damage to the tank/liner/product or effect the ability of the heating system to maintain temperature. The high limit temperature setting must not exceed the minimum of the following:

- Maximum tank wall exposure temperature
- Maximum tank liner or tank contents exposure temperature
- Maximum heater exposure temperature

****Consult HTD for assistance in determining correct high limit temperature setting.**

Low Temperature Alarm setting

A low temperature alarm is generated when the process temperature drops below the low temperature alarm setting.

High Temperature Alarm Setting

A high temperature alarm is generated when the process temperature exceeds the high temperature alarm setting.

Low Current Alarm Setting

The low current alarm can be set to off or the desired current alarm point, the default setting is “off”. See provided 2XTC Controller Suggested Current Alarm Settings” envelope provided with the controller for setting examples.

****Contact HTD Heat Trace for assistance in calculating current alarm setting**

System Access Code

The System Access Code (SAC) limits the allowable values for the process and over temperature settings as well as what preset values can be accessed. For details on the SAC see the full 2XTC manual.

13) Heating System Status Indication

The 2XTC controller has 5 lights under the “STATUS” heading on the front panel. Status indication includes:

- The heater on light is illuminated when the heaters are energized.
- The over temperature light is illuminated when the heating system operation is being limited by the over temperature set value.
- Low temperature alarm light is illuminated when the process value is below the low temperature alarm set value.
- High temperature alarm light is illuminated when the process value is above the high temperature alarm set value.
- The low current alarm light is illuminated when the operating current is below the current alarm set value. This alarm is latching and must be reset after low current alarm condition is fixed.

14) Adjusting Main Menu Settings

Default Settings

Process Temp. SP	50F
High Limit Temp. SP	150F
Low Temp. Alarm SP	40F
High Temp. Alarm SP	100F
Lo Current Alarm SP	OFF

1. Scroll to the desired parameter using the Up/Down arrow buttons.
2. The corresponding LED to the left of the display will illuminate as each parameter value (Process or High Limit Temp, Low or High Temp Alarm Set point or Current in Amps) is displayed.
3. To view or change a set point press and hold the SEL button for 2 seconds until the LED begins blinking and corresponding set point is displayed.
4. The set point value can now be changed using the Up/Down arrow buttons.
5. Press SEL again to save the new set point value, LED will stop blinking. Menu inactivity timeout will also save changes. Pressing RST will exit the menu without saving changes.
6. Repeat steps 1 through 5 to change another set point.

15) Post Installation Testing and Setup

Heater Testing

- 1) Complete testing of the heaters as per the appropriate installation instructions. Testing should include correct heater resistance and insulation resistance (IR) values $\geq 20M\Omega$.
- 2) After successful heater testing connect the heaters as shown in on the wiring diagram shown on page 2.

Power Up

- 1) With the display plate closed turn on customer power to the heating system.
- 2) Verify the controller display lights up and no error codes are shown.
- 3) Correct power wiring if necessary.
- 4) Set the desired operating controller operating parameters.
- 5) Raise the process temperature setting until the “Heater On” light illuminates. Scroll down to the current set light and confirm the correct current.
- 6) If current is correct return process temperature setting to the original value.
- 7) Secure the controller cover by tightening all 6 screws. Maximum tightening torque 10 in-lb.(120 N-cm)

15) Contact information

Installation and Setup Support

Telephone: 908 788-5210

Email: support@htdheattrace.com

Technical support is available from 8:00 am to 4:30 PM EST Monday through Friday at 908 788-5210 option 2.

Sales

For additional heaters, cord grips, aluminum tape or other accessories contact HTD Heat Trace. Contact information:

Telephone: 908 788-5210 Option 1

Email: sales@htdheattrace.com

Normal business hours are 8:00 am to 4:30 PM EST Monday through Friday.



8 Bartles Corner Road, Unit 104, Flemington, NJ 08822 • 908 788-5210 • Fax 908 788-5204

**Installation, Operation and
Maintenance Manual
for
The 2XTC Tank Heating Controller**

**Revision 5
December 11, 2020**

2XTC-OM

Table Of Contents

Title Page	i
Table of Contents	ii-iv
Figure and Tables	v
Appendices	v
Chapter 1	
1.1 System Overview	1
1.2 Controller Specifications	1
1.3 Approval	2
Chapter 2	
General Information	
2.1 Controller Location	3
2.2 General Wiring Diagram	3
2.3 Heater Connection	3
2.4 Power Connection	4
2.5 Signal Connections	4
2.6 RTD Connections	4
Chapter 3	
Connection and Routing	
3.1 Heater Connection	5
3.2 Sensor Location	6
Chapter 4	
Controller Installation	
4.1 Physical Installation	7-8
Chapter 5	
Power Supply Connection	
5.1 Power Supply Requirements	9
5.2 Customer Connection	10

Table Of Contents (continued)

Chapter 6

Signal Connections

6.1	RTD Connections	11
6.2	Alarm Output	11
6.3	Retransmission Output	11
6.4	Signal Connection Diagram	12

Chapter 7

Controller Operation

7.1	General Operation	13
7.2	Main Menu Settings	14-16
7.3	Heating System Status Indication	17
7.4	Adjusting Main Menu Settings	17
7.5	System Setup Parameters	18
7.6	System Setup Adjustment Procedure	18
7.7	Factory Presets	19
7.8	User Preset	20
7.9	Advanced Settings	20
7.10	Power Cycle Reset	20

Chapter 8

Post Installation Testing & Setup

8.1	Testing	21
8.2	Customer Power	21
8.3	Controller	21

Chapter 9

System Maintenance	22
---------------------------	----

Chapter 10

Troubleshooting and Spare Parts

10.1	Troubleshooting Guide	23
10.2	Accessory Parts List	24

Table Of Contents (continued)

Chapter 11

HTD Contact Information

11.1	General	25
11.2	Technical Support	25

Figures and Tables

Figures

<u>Item</u>	<u>Description</u>	<u>Page Number</u>
Figure 1	Heater Connection	5
Figure 2	Sensor Location	6
Figure 3	2XTC Mounting Dimensions	7
Figure 4	Cold Lead Routing	8
Figure 5	Signal Connections	12
Figure 6	Front Plate Layout	13

Tables

<u>Item</u>	<u>Description</u>	<u>Page Number</u>
Table 1	Main Settings Menu	17
Table 2	Main Setup Menu	18
Table 3	Factory Preset Values	19
Table 4	Secondary Setup Menu	20
Table 5	Maintenance Schedule	22
Table 6	Troubleshooting Guide	23
Table 7	Accessory List	24

Appendices

Appendix A	Drawings	A
Appendix B	RTD Specification	B
Appendix C	User Presets	C
Appendix D	System Access Code Settings	D

Chapter One

Overview

1.1 System Overview

The 2XTC Controller is specifically designed for use on non-metallic tanks, lined tanks or tanks with heat sensitive contents in unclassified (non-hazardous) areas. The controller uses process temperature control and high limit temperature protection. Based on the process setting the controller cycles the heating system on and off as needed to maintain the desired temperature. In the event the high limit temperature setting is reached the controller overrides the process and shuts off the heating system to protect the tank, liner or product.

The 2XTC controller is commonly used with tank heaters provided by HTD Heat Trace such as EGLX Tank Heating Panels, SPX tank heating pads or special heaters such as heating cable.

1.2 Controller Specifications

Enclosure Rating:	NEMA4X/IP66, Outdoor
Ambient Temperature Range:	-40°F (-40°C) to 113°F (45°C)
Power Input:	100-277 VAC, 30 A maximum, 50/60 Hz
Process Control Mode:	On/Off with adjustable hysteresis
Alarm Outputs:	(3) SPST NO Relays rated 5A @ 277 VAC/3A @ 30VDC for high temperature, low temperature and low current alarms. Alarm mode selectable for closed on alarm or open on alarm.
Retransmission Output:	4-20 mA for process temperature, adjustable span, 390Ω maximum loop resistance
Qty of Temperature Sensors:	2
Temperature Sensors Type:	1000 Ω platinum RTDs, $\alpha=0.00385$
Temperature Display range:	0-250°F (-18 to 121°C)
Current Display Range:	0-30 Amps

1.3 Approval

The 2XTC Controller is Intertek (ETL) approved to UL 508 and CSA C22.2 14 for use in the US and Canada. The controller is approved for use in unclassified (non-hazardous) locations.



Chapter Two

Controller Installation

2.1 Controller Location

The 2XTC is rated NEMA4X/IP66 and suitable for outdoor installation. The controller should be located at a convenient height for temperature adjustment and out of high traffic areas to minimize the possibility of physical damage. Where possible the controller should be mounted out of direct sunlight to provide maximum visibility for display and indicating lights.

2.2 General Wiring Details

To connect heaters, power and signals it is necessary to remove the clear cover of the enclosure remove the brass thumb knob to allow the hinged plate to be raised. Incoming power supply is connected to the terminal block in the lower left corner of the enclosure with ground connected to the ground bar. Heater connections are completed using the quick connect terminals in the center area. Signal connections such as RTDs, alarm relays and alarm contacts are completed on the designated terminal blocks.

All holes in the enclosure must be sealed using cord grips, conduit connections and/or hole seals to maintain the NEMA4X/IP66 enclosure rating.

2.3 Heater Connection

Heater connections are routed into the controller using cord grips, conduit fittings or other listed sealing method rated NEMA4X/IP66. Depending on the specific controller option ordered it may include 1/2" NPT clearance holes for connecting heaters into the controller and 3/8" NPT clearance holes for RTD connection. Any holes not used must be sealed using a listed NEMA4X/IP66 sealing fitting. See Chapter 4 section 4.1, 3 for additional details.

Heater electrical connections are made using fully insulated quick connect terminals for 1/4" tabs supplied on the heater or by the installer.

2.4 Power Connection

The most common controller configuration includes a ½” NPT clearance hole (Ø0.84”) provided in the lower left enclosure wall for bringing power connection into the controller. When routing power into the controller the clearance hole must be sealing using a NEMA4X/IP66 rated conduit fitting or cord grip (where allowable by Code).

2.5 Signal Connections

In the most common controller configuration a ½” NPT clearance hole (Ø0.84”) is provided in the upper left enclosure wall for bringing signal connections into the controller. Signal connections into the controller the clearance hole must be sealed using a listed NEMA4X/IP66 conduit fitting or cord grip (where allowable by Code). If this hole is not used it must be sealed using a listed NEMA4X/IP66 hole seal.

2.6 RTD Connections

In the most common configuration the controller includes two 3/8” NPT clearance holes (Ø0.68”) in the right enclosure wall for bringing the RTD wires. The RTDs are connected to the terminal blocks labelled RTD1 and RTD2. RTD1 is the process temperature sensor and RTD2 is the high limit temperature sensor. RTD connections into the controller the clearance hole must be sealing using a NEMA4X/IP66 rated cord grip. In most cases the controller is provided with RTDs and cord grips pre-wired from HTD Heat Trace with 10’ long leads. When supplied by HTD the process temperature RTD is labelled PCS and high limit temperature HLS.

Chapter Three

Connection and Routing

3.1 Heater Connection

- 1) For heaters having the same voltage rating as the power supply complete heater connections as shown in figure 1. The controller can be used on voltages from 100 to 277 VAC however the heaters used must match the supply voltage. ***Failure to correctly match the heaters to the supply voltage can result in damage to the heated surface, the heaters, and/or 2XTC controller. For heaters requiring series connections contact HTD for wiring details.***

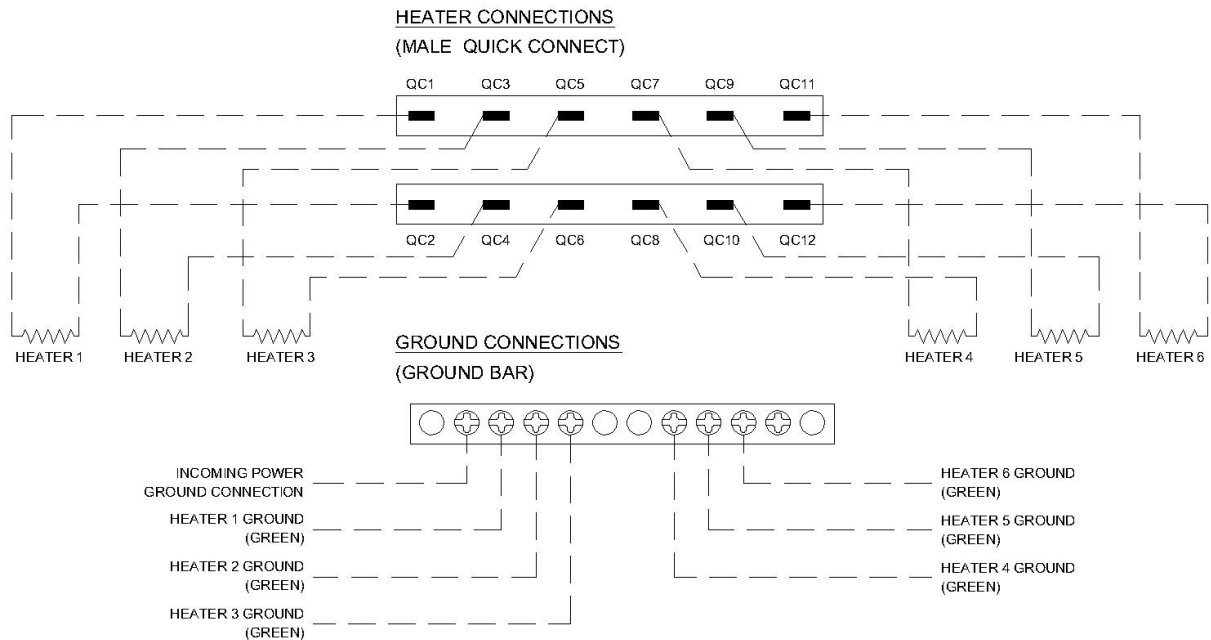

Heater Connection

Figure 1

- 2) Connect the black lead and the white leads on each heater using fully insulated quick connect terminals. Factory installed terminals are provided with some heaters, otherwise the heater lead connections must be accomplished with fully insulated terminals for 16AWG wire and ¼” wide x 1/32” thick tab. Black heater leads should be connected to the odd numbered tabs and white leads to the even numbered tabs. To aid in troubleshooting connect heaters as shown in Figure 1. The green (ground) leads must be connected to the grounding bar as per wiring diagram. ***Maximum current draw for any one (1) pair of heater terminals must not exceed 20 Amps.***

3.2 Sensor Location

- 1) The temperature sensor designated as “PCS” inside the control package must be located as per fig 2 and installed on the tank surface using aluminum tape.

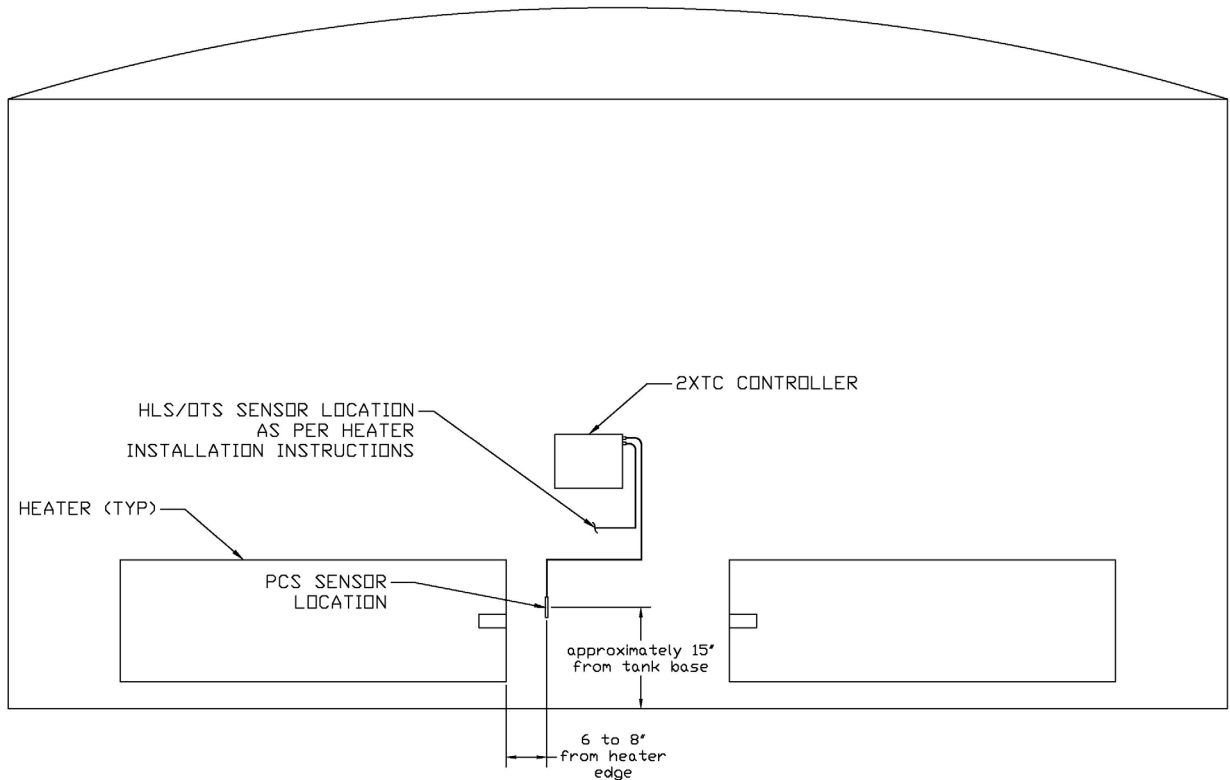

Sensor Location
Figure 2

- 2) The temperature sensor that is designated “HLS” must be located as detailed in the specific heater installation instructions referred to as HLS or OTS [Over Temperature Sensor]. Correct location of the HLS sensor is critical to safe heating system operation.
- 3) Route the temperature sensor leads as shown in fig 5 using 4” strips of aluminum tape. Excess sensor lead should be coiled neatly under the control package and protected.

Chapter Four

Controller Installation

4.1 Physical Installation

- 1) Mount the control package in the location determined during the heater installation. Mounting dimensions using 2XTC enclosure mounting feet as show below. 2XTC controller mounting pads are available from HTD Heat Trace by contacting sales@htdheattrace.com or 908 788-5210 option 1. The mounting pad provide a quick and easy method for mounting the controller using adhesive backing.

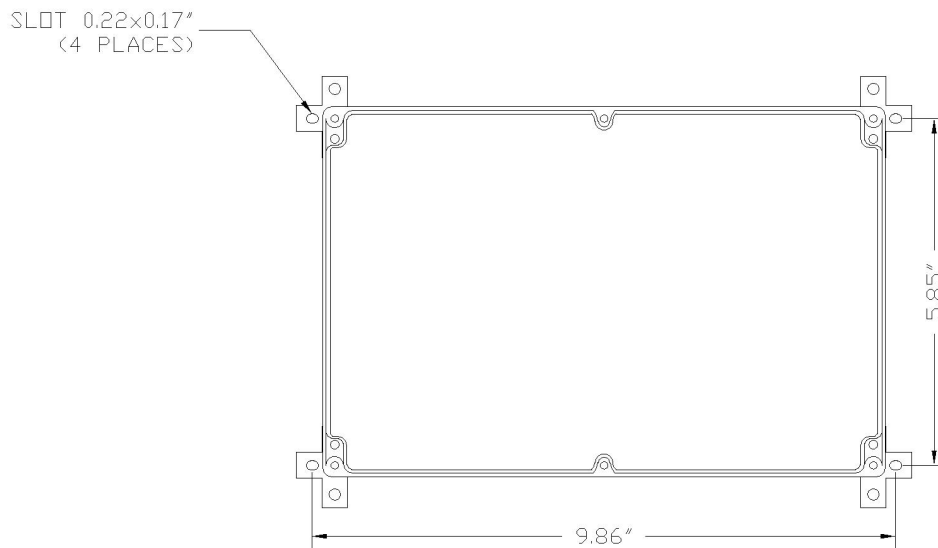

2XTC Controller Standard Mounting Feet.

Figure 3

- 2) Run the cold leads from each heater to a common point below the control package. Cold leads should be secured to the tank with 4" long strips of aluminum tape as shown in fig 2.

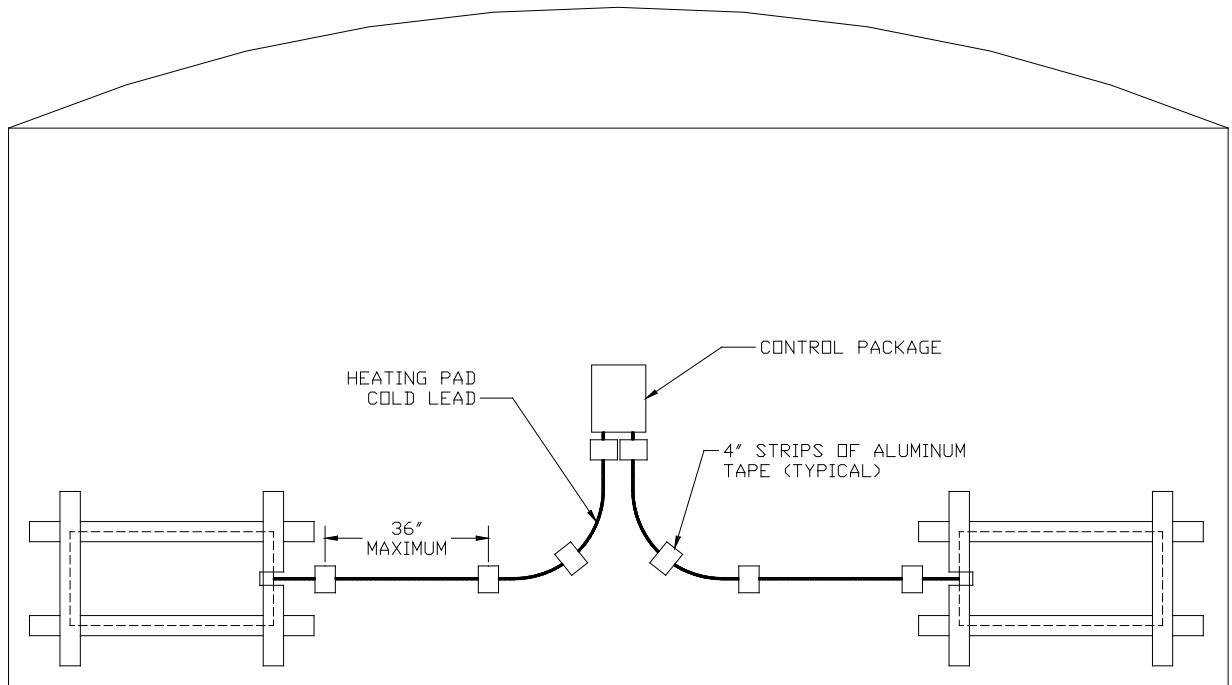

Cold Lead Routing

Figure 4

- 3) Heater leads must be routed into the controller using cord grips, conduit fittings or other listed NEMA4X/IP66 sealing method. Allow approximately 6" of cold lead for termination inside the control package. Any clearance holes not used must be sealed with a listed NEMA4X/IP66 sealing method. Cord grips and hole plugs are available from HTD Heat Trace by contacting sales@htdheattrace.com or 908 788-5210 option 1.

Chapter Five

Power Supply Connection

5.1 Power Supply Requirements

The required customer supply to the controller is 100-277 VAC, 50/60HZ depending on the heaters being used. ***Supply voltage must match the heater design voltage to prevent damage to the heaters or surface being heated.*** The controller has a maximum current of 30 Amps and is labeled to reflect the maximum rating of the controller. The incoming power supply should be sized to fit the specific heating system supplied.

US and Canadian Electric Codes require that all heat tracing systems have ground fault protection. Circuit breakers are commonly available to provide equipment level ground fault protection. Circuit breakers for protection of tank heating systems should be 30 mA trip units. *GFI type breakers with a 5 mA ground fault are trip designed for personnel protection are not suitable for equipment protection and can cause nuisance tripping.*

Circuit Breaker Sizing Criteria:

1. Determine the power of the heating system.
2. Divide the heating system power by system voltage to determine the nominal current.
3. Size the circuit breaker at 125% of the heating load minimum or as required by applicable code.
4. Choose the circuit breaker that most closely matches the calculation, see example.

Example:

1. A heating system with 2 – SPX420 heating pads has a power of 840 watts on 120 VAC.
2. By dividing the power by the voltage $840\text{w}/120\text{ VAC}$ is 7 A.
3. Sizing the circuit breaker at 125% requires a circuit breaker of 8.75 A or greater.
4. Pick the closest circuit breaker that is not less than 125% of the nominal load. The lowest commonly available circuit breaker trip setting is 15 A. Use a 15A, 120VAC, 30mA ground fault protected circuit breaker.

5.2 Customer Connection

Incoming power to the controller must be routed into the controller using a listed NEMA4X/IP66 sealing method such as a conduit fitting or cord grip (where allowable by code). Incoming power terminal blocks accept 10 AWG maximum wire size. The torque rating for the incoming power terminal blocks is 9.0 in-lb., **DO NOT OVERTIGHTEN.**

Chapter Six

Signal Connections

6.1 RTD Connections

The 2XTC controller uses 2 RTD temperature sensors one for process temperature and one for over temperature protection. Both RTDs are platinum, 1000 Ω , 2 wire sensors as per the specification in Appendix B. Both RTDs must be connected for the controller to operate.

6.2 Alarm Output

Alarm outputs are provided for low temperature, high temperature and low current. In the event of an alarm the appropriate indicating light on the front of the controller illuminates. Also in the event of an alarm the appropriate relay contacts change state. The alarms contacts are software selectable for close on alarm or open on alarm.

6.3 Retransmission Output

A retransmission output is provided to remotely indicate the process value. The signal is 4 to 20 mA with an adjustable span by setting the minimum and maximum temperature values. On sensor failure or over/under range the retransmission output goes to 23 mA. The equipment used to measure this signal must have an input resistance of $\leq 390\Omega$.

6.4 Signal Connections

SIGNAL CONNECTIONS

(TERMINAL BLOCKS)

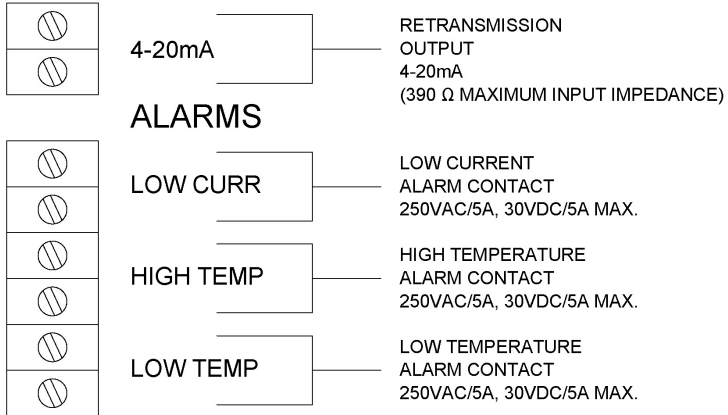

POWER CONNECTION

(TERMINAL BLOCKS)

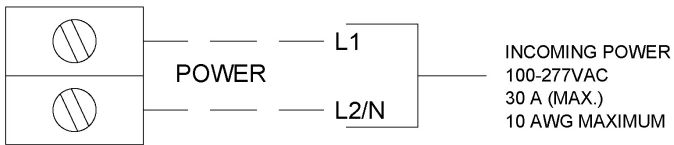

RTD CONNECTIONS

(TERMINAL BLOCKS)

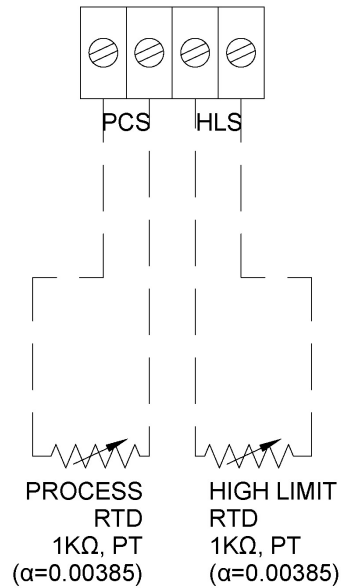

Figure 5

Chapter Seven

Controller Operation

7.1 General Information

The type 2XTC controller has two operating temperature settings. The PCS sensor is for control of the process temperature and the HLS for high limit temperature protection. The heating system is energized when the process temperature drops below the set point. The heating system stays energized until the process temperature exceeds the set point. In this manner the desired tank temperature is maintained by cycling the heating system on and off as required.

The HLS sensor shuts off the heating system if a heater temperature exceeds the high limit temperature setting. This protects the tank and/or product from over temperature caused by upset conditions, such as low liquid level.

System status both set values and process values are indicated by lights on the front plate of the controller.

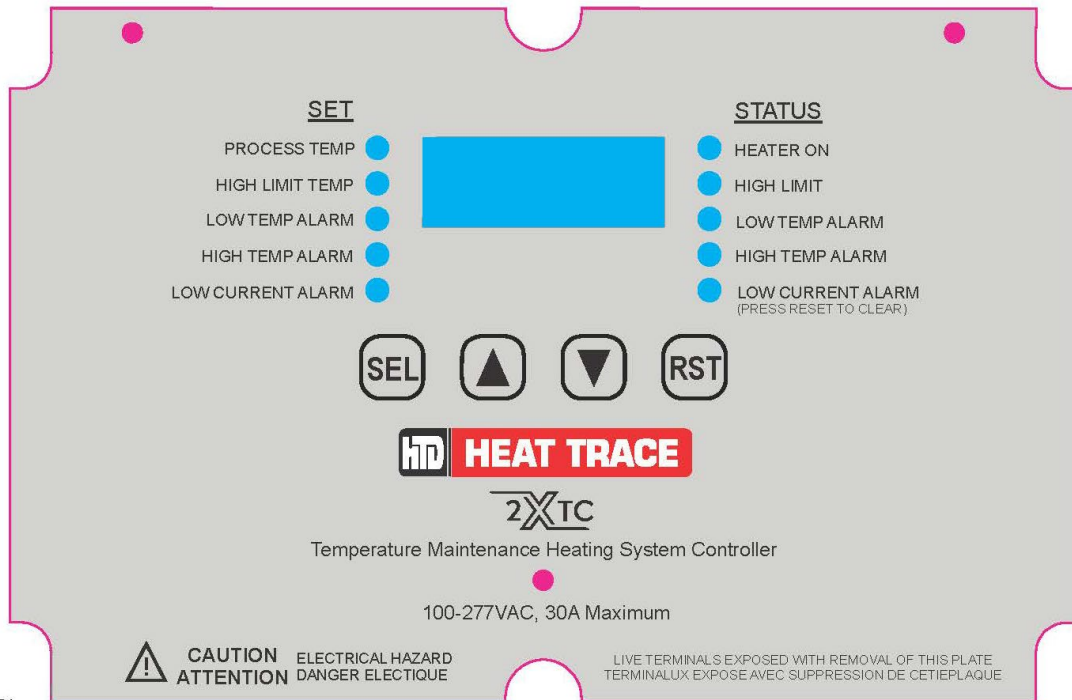

Figure 6

Values under the “SET” notation are values set by the user and also display process values. Indication under STATUS shows heating system operation and alarm status.

7.2 Main Menu Settings

The 2XTC has 5 control and alarm settings listed under the “SET” heading:

- Process Temperature (PROCESS TEMP)
- High Limit Temperature (HIGH LIMIT TEMP)
- Low Temperature Alarm (LOW TEMP ALARM)
- High Temperature Alarm (HIGH TEMP ALARM)
- Low Current Alarm (LOW CURRENT ALARM)

The values can be seen and adjusted using the keys on the hinged plate assembly. The controller defaults to displaying the process temperature indicated by the light next to “PROCESS TEMP” illuminated. When the light is solidly lit the display is showing the process temperature.

7.2.1 Process Temperature Setting

The process set value should be adjusted to the desired process temperature. Standard system designs are limited to a maximum maintain temperature of 100°F. Contact HTD Heat Trace for applications with process settings above 100°F.

7.2.2 High Limit Temperature Setting

The high limit temperature set value protects the tank, tank liner or product from high heater temperatures. If the heating pad reaches the high limit temperature setting the heating system is shut off to protect the tank or heat sensitive component. The 2XTC controller includes factory presets to cover the majority of heating applications. See Appendix C for all preset options. Default 2XTC set values are 60°F for process set value and 150°F for high limit temperature set value.

The 2XTC high limit temperature set value can be adjusted to match the application. Incorrect over-temperature setting can cause damage to the tank, tank liner, product or heater. ***Incorrect high limit temperature settings may result in damage to the tank/liner/product or effect the ability of the heating system to maintain temperature.*** The high limit temperature setting must not exceed the minimum of the following:

- a. Maximum tank wall exposure temperature
- b. Maximum tank liner or tank contents exposure temperature
- c. Maximum heater exposure temperature

****Consult HTD for assistance in determining correct high limit temperature setting.**

7.2.3 Low Temperature Alarm setting

A low temperature alarm is generated when the process temperature drops below the low temperature alarm setting. The differential between the process temperature and low temperature alarm must be large enough to prevent an alarm during normal operation. Using default system settings a differential of 5°F is usually sufficient.

7.2.4 High Temperature Alarm Setting

A high temperature alarm is generated when the process temperature exceeds the high temperature alarm setting. The differential between the process temperature and high temperature alarm must be large enough to prevent an alarm during normal operation. Using default system settings a differential of 5°F is usually sufficient. It is also important to mention with the alarm set below the summer ambient temperatures it is possible for the tank temperature to exceed the high temperature alarm setting with no contribution from the heating system.

7.2.4 Low Current Alarm Setting

The low current alarm can be set to off or the desired current alarm point. The controller default setting is off so no current alarm is generated under any circumstance. The current alarm setting should be based on the wattage of the heating system, design voltage, actual voltage and voltage fluctuations. To get your heating system wattage take the wattage of each heater and multiply by the number of heaters to get the total wattage installed. For example if a tank has 4 each 420 watt heaters and 2 each 210 watt heaters the total system load is $4 \times 420W + 2 \times 210W = 2100$ watts. If the supply voltage matches the heater rated voltage use the **Standard Low Current Alarm Calculation**. If the supply voltage is lower than the heater rated voltage use **Reduced Supply Voltage Low Current Alarm Calculation**.

Standard Low Current Alarm Calculation

If the supply voltage matches the voltage of the heaters being used the alarm setting can be set at shown below:

- 1) Take the total heating system wattage divided by the supply voltage to get the nominal current.
- 2) Multiply the nominal current by 74% to allow for supply voltage variation and heater manufacturing tolerance.
- 3) Set the current alarm to the setting calculated in step 2 rounded to the nearest tenth.

Example Calculation:

- a) With a tank heating system using a power supply of 120 VAC and 120 VAC rated heaters consisting of 4 each 420 watt and 2 each 210 watt the total system load is $4 \times 420W + 2 \times 210W = 2100$ watts. The nominal current is then $2100\text{watts}/120\text{ VAC} = 17.5$ amps.
- b) Multiply the nominal current of 17.5 amps x 74% = 12.95.
- c) Set the current alarm setting to 13.0 amps.

Reduced Supply Voltage Low Current Alarm Calculation

If the operating voltage is below the heater rating the current draw calculation must be adjusted. Procedure to calculate the current alarm setting is shown below:

- 1) Take the square of the actual supply voltage divided by the heater rated voltage squared to get the power adjustment factor
- 2) Take the heater rated wattage multiplied by the number of heaters to get the nominal power. Take that calculated number and multiply by the power adjustment factor calculated in step 1 to get the nominal current.
- 3) Take the nominal current and multiply by 74% to account for supply voltage variation and heater manufacturing tolerance.
- 4) Set the current alarm to the setting calculated in step 3 rounded to the nearest tenth.

Example Calculation:

- a) With a tank heating system with a power supply of 110 VAC and 120 VAC rated heaters the adjustment factor is $110\text{VAC}^2/120\text{VAC}^2 = 84\%$.
- b) A heating system consisting of 4 each 420 watt and 2 each 210 watt the total system load is $4 \times 420\text{W} + 2 \times 210\text{W} = 2100$ watts nominal power. Take the nominal wattage of 2100 watts multiplied by the power adjustment factor of $84\% = 1764$ watts. The nominal current is 1764 watts divided by the supply voltage of 110 VAC to get 16.04 amps.
- c) Take the nominal current of 16.04 and multiply $\times 74\% = 11.87$.
- d) Set the current alarm setting to 11.9 amps.

*****Contact HTD Heat Trace for assistance in calculating current alarm setting***

7.2.5 System Access Code

The System Access Code (SAC) limits the allowable values for the process and over temperature settings as well as what preset values can be accessed. The factory default setting is 17 which limits the maximum process set point to 100°F and high limit maximum setting to 150°F. This default settings also allows access to Factory Presets 1 to 6. Changing the SAC can allow potentially harmful settings that could result in damage to the tank wall, tank contents, tank lining, heaters, etc. See Appendix D for additional SAC setting information.

7.3 Heating System Status Indication

The 2XTC controller has 5 lights under the “STATUS” heading on the front panel. Status indication includes:

- The heater on light is illuminated when the heaters are energized.
- The over temperature light is illuminated when the heating system operation is being limited by the over temperature set value.
- Low temperature alarm light is illuminated when the process value is below the low temperature alarm set value.
- High temperature alarm light is illuminated when the process value is above the high temperature alarm set value.
- The low current alarm light is illuminated when the operating current is below the current alarm set value. This alarm is latching and must be reset after low current alarm condition is fixed.

7.4 Adjusting Main Menu Settings

Parameter	Default
Process Temperature SP	60F
High Limit Temperature SP	150F
Low Temperature Alarm SP	40F
High Temperature Alarm SP	100F
Current Lo Current Alarm SP	OFF

Table 1 – Main Settings Menu

1. Scroll to the desired parameter using the Up/Down arrow buttons.
2. The corresponding LED to the left of the display will illuminate as each parameter value (Process or High Limit Temp, Low or High Temp Alarm Set point or Current in Amps) is displayed.
3. To view or change a set point press and hold the SEL button for 2 seconds until the LED begins blinking and corresponding set point is displayed.
4. The set point value can now be changed using the Up/Down arrow buttons.
5. Press SEL again to save the new set point value, LED will stop blinking. Menu inactivity timeout will also save changes. Pressing RST will exit the menu without saving changes.
6. Repeat steps 1 through 5 to change another set point.

7.5 System Setup Parameters

System setup parameters define the temperature units, maximum set point values, hysteresis, etc. In most cases these values do not require adjustments.

Parameter	Prompt	Adjustment Range	Default
Temperature Units	<i>F_C</i>	F = Fahrenheit; C = Celsius	<i>F</i>
Max Process SP	<i>P_rHL</i>	0 to 200°F (-18 to 93°C) in 1°F or 1°C steps	<i>100F</i>
Max High Limit SP	<i>HLHL</i>	0 to 250°F (-18 to 121°C) in 1°F or 1°C steps	<i>150F</i>
Process Hysteresis	<i>PHYS</i>	2 to 10°F (1.0 to 5.5°C) in 1°F (0.5°C) steps	<i>2F</i>
High Limit Hysteresis	<i>LHYS</i>	5 to 20°F (3.0 to 11°C) in 1°F (0.5°C) steps	<i>5F</i>
Process Temp offset	<i>P_oFS</i>	0 to +/-50°F (0 to +/-28°C)	<i>0</i>
High Limit Temp Offset	<i>L_oFS</i>	0 to +/-50°F (0 to +/-28°C)	<i>0</i>
Alarm Relay Mode	<i>ArLY</i>	EN=energize on alarm; DE=de-energize on alarm	<i>En</i>
Current test interval (Hrs)	<i>CTP</i>	0=disabled, 24, 168 or 720 hours	<i>168</i>
Retrans Span Min	<i>r_tL</i>	0-200°F (-18 to 93°C) for 4mA	<i>0</i>
Retrans Span Max	<i>r_tH</i>	0-200°F (-18 to 93°C) for 20mA	<i>100</i>

Table 2 – Main Setup Menu Parameters and Default Settings

7.6 System Setup Adjustment Procedure

- a. Press and hold SEL & DOWN buttons for 3 seconds until the first parameter prompt is displayed.
- b. Use the Up/Down arrow buttons to scroll through the parameters – only the prompts are displayed.
- c. To change a parameter value press SEL when the desired parameter prompt is displayed. The parameter value will begin flashing.
- d. Use the Up/Down arrow buttons to change a parameter value.
- e. Press SEL again to move to the next parameter prompt.
- f. Repeat steps 2 through 5 to change additional parameter values.
- g. When all desired parameter values have been changed, press and hold the SEL button for 3 seconds to save all new values and exit the menu. Menu inactivity timeout will also save changes. Press RST to exit without saving changes.

7.7 Factory Presets

Twelve (12) sets of pre-programmed controller operating parameters are available as “Factory Presets” to allow the user to quickly select an appropriate set of parameter values for a specific application. The System Access Setting (SAC) limits accessible presets. The table showing specific settings for each preset are shown in Appendix C. To select a preset # use the procedure below.

Factory Preset Loading Procedure

1. Press and hold SEL and RST buttons for 3 seconds until “fPst” is displayed.
2. Use the Up/Down arrow buttons to scroll to the Preset No. corresponding to the desired application.
3. Press SEL to load these operating parameter values and exit the Presets menu.
4. Press RST to exit with no changes.

Preset #	Abbreviation	Process Temp (°F)	High Limit Temp (°F)	Low Temp. Alarm (°F)	High Temp. Alarm (°F)	Current Alarm
1	PS	60	150	40	100	OFF
2	PSL	60	130	40	100	OFF
3	PDL	60	150	40	100	OFF
4	FP	40	150	35	100	OFF
5	MSPX	60	150	40	100	OFF
6	DEF	25	150	15	100	OFF

*System Access Code (SAC) setting limit access presets 1 to 6 by factory default. See Appendix D for SAC details. Expanded factory preset values shown in Appendix C.

Table 3 – Factory Preset Value Summary

7.8 User Preset

If a specific process has unique setting requirements these values can be saved in the “User Preset” so they can be recalled in the future. The “User Preset” settings are saved to non-volatile memory that can be recalled when needed. To save the currently active parameters to memory as a “User Preset”, press and hold the SEL and Up Arrow buttons until *UPSt* is displayed and then blinks once. The currently active parameters are now saved. Now by loading the User Preset below it is possible to return to the desired settings without having to set each individual parameter.

To recall and load the previously saved “User Preset” parameters, press and hold the Up and Down arrow buttons until “*UPSt*” is displayed and then blinks once. The previously saved “User Preset” operating parameters are now active.

Changing the System Access Code (SAC) can return all settings to factory defaults.

7.9 Advanced Settings

A hidden menu allows access to secondary parameters that seldom need adjustment and/or should not be changed arbitrarily. This menu is accessed by pressing the 4 buttons on the front panel in the following sequence.

SEL, RST, UP, DOWN, SEL

Parameter	Prompt		Default
Menu Inactivity Timeout	<i>nIo</i>	10-120 Seconds	15
Current Alarm Delay	<i>cAd</i>	5 to 10 Seconds	5
Temp Alarm Hysteresis	<i>tAH</i>	1 to 10°F (0.5-5.5°C)	2F
Temp Alarm Delay	<i>tAd</i>	3-30 Seconds	5
Current Interval Test Duration	<i>ltd</i>	15-60 Seconds	15
System Access Code	<i>SAC</i>	See Appendix D	17

Table 4 - Secondary Setup Menu

**After making changes press SEL to save parameter or allow menu inactivity time out. Press RST to exit without saving changes.

7.10 Power Cycle Reset

1. Remove power from the controller.
2. Press and hold the Up arrow, Down arrow and RST buttons while reapplying power to the controller.
3. Continue holding the three buttons until the software version number is displayed, then release.

Note: Resetting the controller in this way restores all the factory default values, thus requires all user modified setup parameters to be reprogrammed before using.

Chapter Eight

Post Installation Testing and Setup

Some testing requires exposure to electrically live components and should only be completed by an electrician or other qualified personnel.

8.1 Testing

- 1) Complete testing of the heaters as per the appropriate installation instructions. Testing should include correct heater resistance and insulation resistance (IR) values $\geq 20M\Omega$.
- 2) After successful heater testing connect the heaters as shown in figure 1 on page 5.

8.2 Customer Power

- 1) With the display plate closed turn on customer power to the heating system.
- 2) Verify the controller display lights up and no error codes are shown.
- 3) Correct power wiring if necessary.

8.3 Controller

- 1) Set the desired operating controller operating parameters as shown in Chapter 6.
- 2) Raise the process temperature setting until the “Heater On” light illuminates. Scroll down to the current set light and confirm the correct current.
- 3) If current is correct return process temperature setting to the original value.

Chapter Nine

System Maintenance

Maintenance Schedule

Procedure	Frequency*	Recommendations
Voltage Check (voltmeter)	Every 6 Months	a) Reduced voltages should be evaluated to determine decreased power levels and the potential impact on the performance of the tank heating system. b) Operating voltages over 10% above the heater rating are not acceptable. De-energize the system and investigate cause of over-voltage. Do not re-energize the system until the cause of excess voltage is eliminated.
Current Check	Every 6 Months	Verify correct current draw based on the size of the heating system. Verify by raising set values to energize the heater and confirm correct current using the controller current display by scrolling to the current set value.
Functional Check	Every 6 Months	Verify the controller is working correctly by adjusting the process temperature setting to turn on and off the heating system.
Physical	Every 6 months	a) Clean the controller exterior with a damp cloth to remove any dirt, dust or debris. b) Check the controller interior for dust, dirt, or moisture. Wipe out the interior using a lint free cloth to remove dust/dirt and moisture as necessary.

Table 5 – Maintenance Schedule

*Inspection frequency should be evaluated based on the process type. Freeze protection systems for example may only require inspection once a year prior to freezing temperatures in the fall. Process critical systems should be inspected more frequently.

Chapter Ten

Troubleshooting and Spare Parts

10.1 Troubleshooting Guide

Issue	Possible Cause	Possible Solution
Controller does not light up	<ul style="list-style-type: none"> a. Check power is present b. Correct power connections c. Check ribbon cable connection from power board to display board 	Verify Correct Verify/Correct
Heaters do not energize	<ul style="list-style-type: none"> a. No incoming power b. Incorrect Heater Connections c. Failed or damaged temperature sensor 	Switch on/reset Correct wiring Replace
“Heater on” light does not illuminate	<ul style="list-style-type: none"> a. Heating not required to maintain temp. b. No incoming power c. Incorrect controller settings d. Failed or damaged temperature sensor 	Heat not required Switch on/reset Correct settings or Replace
Low tank Temp.	<ul style="list-style-type: none"> a. No incoming power b. Incorrect controller settings c. Low incoming product temp. d. Damaged/missing thermal insulation e. Low tank liquid level f. Damaged/failed heating pad g. Incorrect heater connections h. Failed or damaged temperature sensor 	Switch on/reset Correct temp. controller settings Wait for product heat up (can take a very long time) Repair or replace insulation Fill Tank Repair or replace Correct wiring Replace
High Tank Temp.	<ul style="list-style-type: none"> a. Incorrect controller settings 	Correct
Customer supplied breaker trips	<ul style="list-style-type: none"> a. Damaged wiring b. Damaged heater c. Incorrect heater connection 	Repair or replace Repair replace Correct wiring
“LO” is displayed	<ul style="list-style-type: none"> a. Process or over temperature value is below 0°F (-18°C) 	Raise temperature
“HI”	<ul style="list-style-type: none"> a. Process or over temperature value is above 200°F (93°C) for process or 250°F (121°C) over temperature 	Lower temperature
PRB1	<ul style="list-style-type: none"> a. Process temperature sensor fault 	Correct wiring, verify correct sensor type or replace sensor
PRB2	<ul style="list-style-type: none"> a. Over temperature sensor fault 	Correct wiring, verify correct sensor type or replace sensor
ERR	<ul style="list-style-type: none"> a. Controller error 	Power Cycle Reset the controller as described in Chapter 7, Section 10.

Table 6 - Troubleshooting

10.2 Accessory and Spare Parts List

<u>HTD Part#</u>	<u>Item</u>
H05900	RTD Sensor 1000 K Ω , 10' leads, 2 wire
H01223	Cable gland sealing insert
H01210	Lever nut 32A, 600VAC, AWG 24 - 12 solid, stranded, flexible for series connections
G01221	Heater or Power Cord grip (including sealing ring and nut)
G01222	RTD Sensor Cord grip (including sealing ring and nut)
586DB-1	2XTC Display Board
586PB-1	2XTC Power board
2XTCMP	Controller mounting pad assembly
2XTC-RC	2XTC Ribbon Cable
2XTC-MB	2XTC Mounting bar for controller mounting using banding

Table 7

Chapter Eleven

HTD Heat Trace Contact Information

11.1 General Contact Information

HTD Heat Trace can be contacted via any of the methods listed below:

Mail and Physical Address

HTD Heat Trace, Inc.
8 Bartles Corner Rd, Unit 104
Flemington, NJ 08822

Phone

Telephone: 908 788-5210
Fax: 908 788-5204

E-mail: support@htdheattrace.com

11.2 Technical Support

Technical support is available from 8:00 am to 4:30 PM EST Monday through Friday at 908 788-5210 option 2.



8 Bartles Corner Road, Unit 104, Flemington, NJ 08822 • 908 788-5210 • Fax 908 788-5204

Appendix A

Drawings

REVISIONS

REV	DESCRIPTION	APPROVED	DATE
-	INITIAL RELEASE	SRB	1/28/19

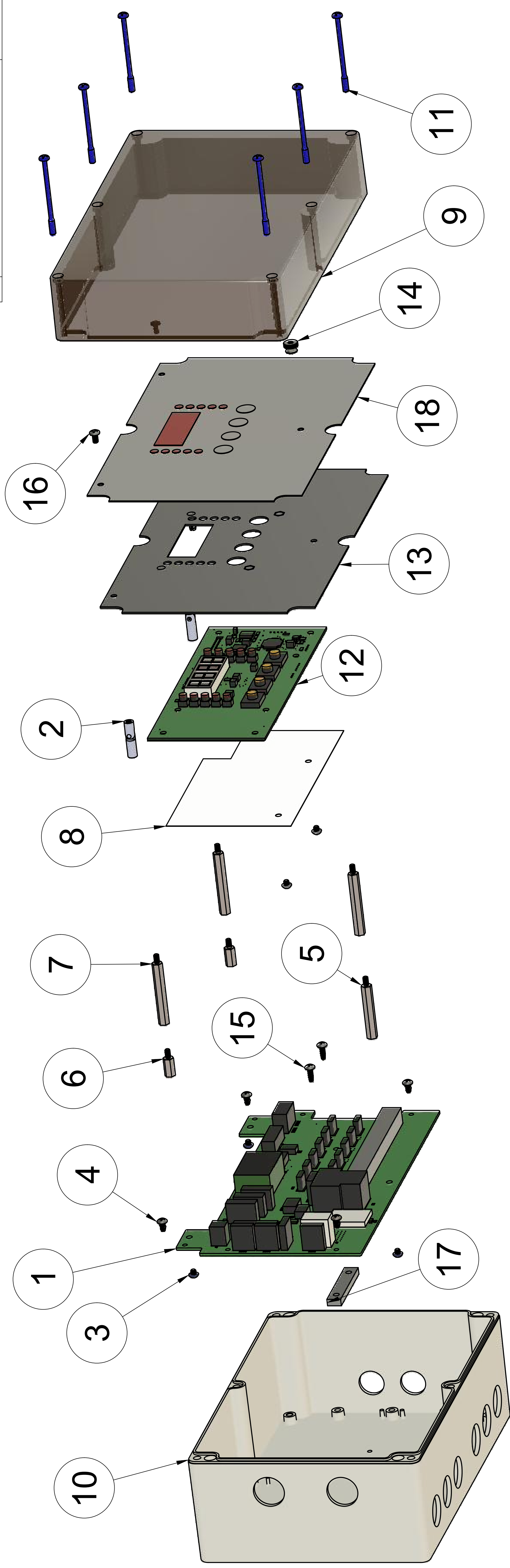

CONTROLLER RATINGS
OPERATING TEMPERATURE: -40 TO 41°C/-40 TO 105°F
ENVIRONMENTAL RATING: NEMA4X/IP66
OPERATING VOLTAGE: 100-277VAC
MAXIMUM CURRENT: 30 A
ALARM CONTACT RATING: 250VAC/3A, 30VDC/5A

NOTES:

- 1) STANDARD ENCLOSURE HOLE PATTERN SHOWN.
- 2) CONTROL ENCLOSURE AVAILABLE IN MULTIPLE CONFIGURATIONS OF CLEARANCE HOLES CONTACT HTD HEAT TRACE (908) 788-5210 FOR ADDITIONAL INFORMATION.
- 3) SEE SHEET 2 FOR WIRING CONNECTIONS.

PARTS LIST

ITEM	QTY	PART NUMBER	DESCRIPTION
17	1	31-2123	TERMINAL SUPPORT SPACER
18	1	47-1020	FRONT PANEL ASSEMBLY

PARTS LIST

ITEM	QTY	PART NUMBER	DESCRIPTION
1	1	586PB-1	POWER BOARD ASSEMBLY
2	2	31-2210-2	HINGED STANDOFF, F/F, 6-32, 1.00" L
3	5	30-1002-18	PPH SCREW, 6-32x5/16" LW/EXT TOOTH WASHER
4	4	30-1023	PPH THREAD-FORMING SCREW (BOPLA59006101)
5	1	31-2202-12	HEX STANDOFF, M/F, 6-32, 1.500" L
6	2	31-2202-4	HEX STANDOFF, M/F, 6-32, 0.500" L
7	3	31-2202-14	HEX STANDOFF, M/F, 6-32, 1.750" L
8	1	31-4037	DISPLAY BD INSULATING SHIELD
9	1	31-3162-2	ENCLOSURE COVER, CLEAR
10	1	31-3162-1	MODIFIED ENCLOSURE BASE
11	6	30-1026	COVER SCREWS, BOPLA#02243100
12	1	586DB-1	DISPLAY BOARD ASSEMBLY
13	1	31-3163-1	FRONT PANEL ASSEMBLY
14	1	30-2006	KNURLED-HEAD THUMB NUT, 6-32
15	2	30-1024-6	THREAD-FORMING SCREWS
16	2	30-1002-17	COVER SCREWS

MODEL	ITEM	QTY	PART NO.	DESCRIPTION
SIGNATURES	SRB	1/28/19	HTD	HTD HEAT TRACE, INC.
DWN:	SRB			FLEMINGTON, NEW JERSEY 08822
APVD:				TITLE
QA:				2XTC TEMPERATURE CONTROLLER
DIMENSIONS ARE IN INCHES				
TOLERANCES UNLESS SPECIFIED OTHERWISE:				
2	PL	±0.05	FRACTION	±1/32
3	PL	±0.020	ANGLE	± 1.0°
SCALE:	NONE			
FILE:	2XTC-C			
SHEET	1	OF	2	

THIS DRAWING IS THE PROPERTY OF AND IS PROPRIETARY TO HTD HEAT TRACE, INC., AND SHALL NOT BE DISCLOSED TO, NOR USED BY, ANY THIRD PARTIES WITHOUT EXPRESS WRITTEN CONSENT OF HTD HEAT TRACE.

REVISIONS

REV	DESCRIPTION	APPROVED	DATE
-	INITIAL RELEASE	SRB	1/28/19
A	ALARM RELAY RATING	SRB	2/22/19
B	TERMINAL BLOCK WIRING	SRB	10/27/20

SIGNAL CONNECTIONS
(TERMINAL BLOCKS)

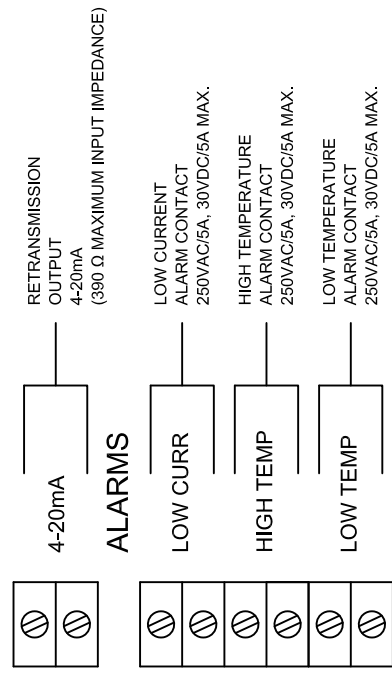

RTD CONNECTIONS
(TERMINAL BLOCKS)

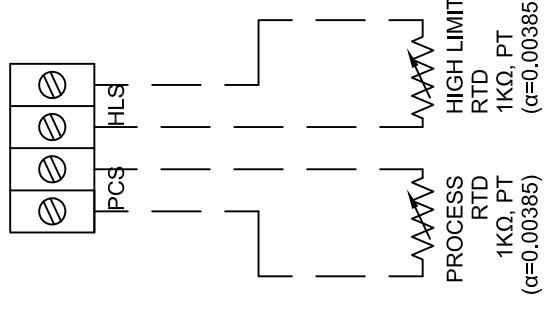

HEATER CONNECTIONS
(MALE QUICK CONNECT)

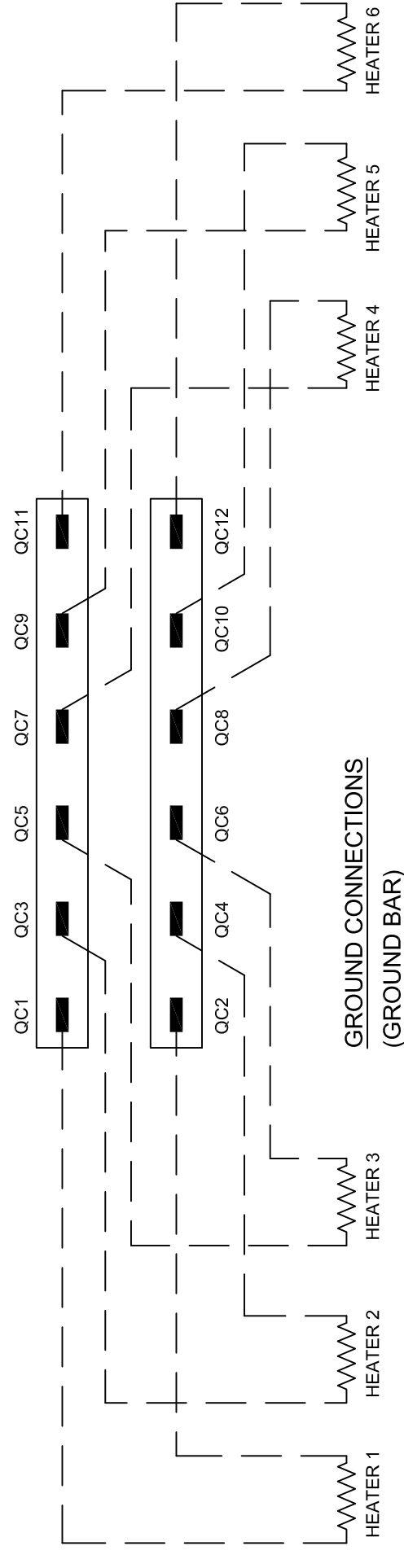

GROUND CONNECTIONS
(GROUND BAR)

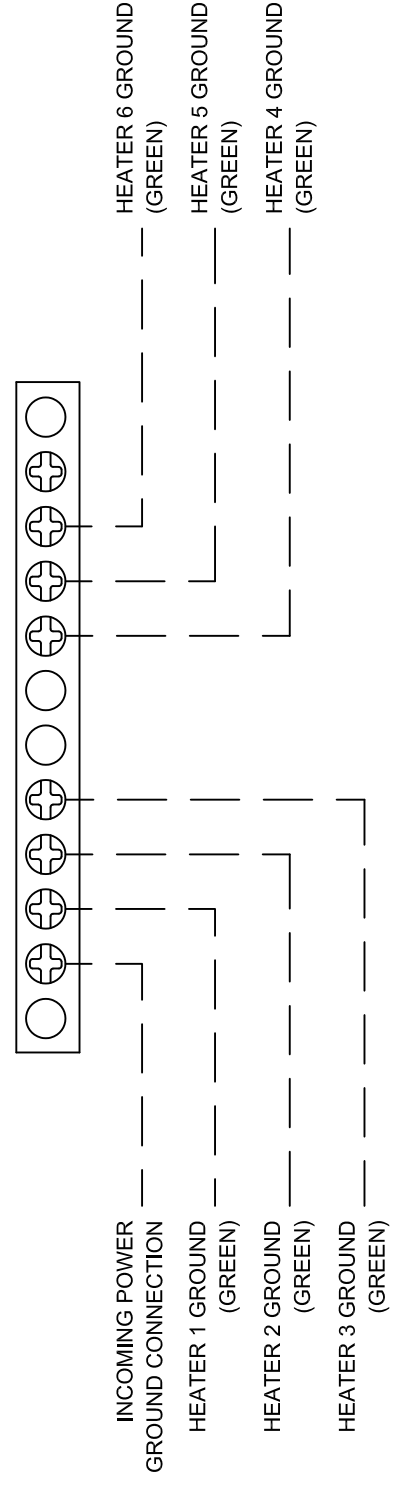

NOTES:

- 1) CONTROLLER CONSTRUCTION AND BILL OF MATERIALS SHOWN ON SHEET 1.
- 2) INCOMING POWER MUST MATCH HEATER VOLTAGE TO PREVENT DAMAGE TO THE HEATER(S) AND/OR HEATED SURFACE.
- 3) HEATER CONNECTIONS USING QUICK CONNECT/FLAG TERMINALS FOR 0.25" WIDE X 0.032" THICK TABS. FULLY INSULATED AND MUST INCLUDE NRTL LISTING FOR THE US AND CANADA.
- 4) SIGNAL AND RTD TERMINALS ACCEPT WIRE SIZES 12-26 AWG OR EQUIVALENT.
- 5) CONTACT HTD HEAT TRACE (908) 788-5210 OPTION 2 FOR TECHNICAL SUPPORT.

THIS DRAWING IS THE PROPERTY OF AND IS PROVIDED TO THE CLIENT BY HTD HEAT TRACE, INC. NO PARTS OR INFORMATION FROM THIS DRAWING IS TO BE REPRODUCED OR USED IN ANY MANNER WITHOUT EXPRESS WRITTEN CONSENT OF HTD HEAT TRACE

MODEL	ITEM	QTY	PART NO.	DESCRIPTION
SIGNATURES	DATE			
DWN: SRB	1/28/19			HTD HTD HEAT TRACE, INC. FLEMINGTON, NEW JERSEY 08822
APVD:				TITLE
OK:				2XTC TEMPERATURE CONTROLLER NEMA4X, 100-277 VAC, 30 A LAYOUT AND WIRING CONNECTIONS
DIMENSIONS ARE IN INCHES TOLERANCES, UNLESS SPECIFIED OTHERWISE:				
2	PL ±0.05	FRACTION ±1/32	CONTRACT NUMBER	DRAWING NUMBER
3	PL ±0.020	ANGLE ±1.0°	NONE	2XTC
SCALE:	NONE	FILE:	2XTC-C-P2RB	SHEET 2 OF 2



8 Bartles Corner Road, Unit 104, Flemington, NJ 08822 • 908 788-5210 • Fax 908 788-5204

Appendix B

RTD Specifications

RTD Element Specifications

Parameter	Value
Element Type	RTD
Nominal Resistance:	1000 Ω @0°C
α :	0.00385 $\Omega/\Omega/^\circ\text{C}$
Element Class:	A or B
No. of Wires:	2
Maximum Temperature Exposure:	300°F/150°C

**Nominal wire size 24 AWG with 10' long leads. For longer lead lengths and smaller wire gauge contact HTD Heat Trace for potential effects on temperature measurement.



8 Bartles Corner Road, Unit 104, Flemington, NJ 08822 • 908 788-5210 • Fax 908 788-5204

Appendix C

Detailed Preset Parameters

Detailed Preset Parameter List

Preset Number*	1	2	3	4	5	6	7	8	9	10	11	12	
Reference	PS	PSL	PDL	FP	MSPX	DEF	PD	FG1	FG2	FG3	MSPXC	MEGLX	
Main Setpoint Menu	Process Temp	60	60	60	40	60	25	60	60	60	60	60	
	High Limit Temp	150	130	150	150	150	150	175	150	180	200	220	
	Low Temp Alarm	40	40	40	35	40	15	40	40	40	40	40	
	High Temp Alarm	100	100	100	100	100	100	100	100	100	180	200	
	Low Curr Alarm	OFF	OFF	OFF	OFF	OFF	OFF	OFF	OFF	OFF	OFF	OFF	
Main Setup Menu	F/C	F	F	F	F	F	F	F	F	F	F	F	
	SP Max	100	100	100	100	120	50	100	120	150	180	180	
	HL SP Max	150	130	150	150	150	150	175	150	180	200	220	
	Process HYS	2	2	2	2	2	2	2	2	2	2	2	
	High Limit HYS	5	5	5	5	5	5	5	5	5	5	5	
	Process Offset	0	0	0	0	0	0	0	0	0	0	0	
	High Limit Offset	0	0	0	0	0	0	0	0	0	0	0	
	Alarm Mode	EN	EN	EN	EN	EN	EN	EN	EN	EN	EN	EN	EN
	Current test interval (H)	168	168	168	168	168	168	168	168	168	168	168	168
	Retrans Span Min	0	0	0	0	0	0	0	0	0	0	0	0
Retrans Span Max	100	100	100	100	120	50	100	120	150	180	180	200	
Secondary Menu	Menu time out (S)	15	15	15	15	15	15	15	15	15	15	15	
	Current Alarm Delay (S)	5	5	5	5	5	5	5	5	5	5	5	
	Temp alarm HYS	2	2	2	2	2	2	2	2	2	2	2	
	Temp Alarm delay (S)	5	5	5	5	5	5	5	2	5	5	5	
	Current Test Duration (S)	15	15	15	15	15	15	15	5	15	15	15	

Common Application Settings (See Note 1)

Preset #	Abbreviation	Description
1	PS	Common settings for single wall polyethylene tank
2	PSL	Common settings for low temperature single wall polyethylene tank
3	PDL	Common settings for low temperature double wall polyethylene tank
4	FP	Water freeze protection settings
5	MSPX	SPX Tank heating pad settings
6	DEF	Diesel exhaust fluid freeze protection settings
7	PD	Common setting for double wall polyethylene tank
8	FG1	Low temperature fiberglass tank
9	FG2	Medium temperature fiberglass tank
10	FG3	High temperature fiberglass tank
11	MSPXC	SPX-C Tank heating pad settings
12	MEGLX	EGLX Tank heating panel settings

Note 1: **Caution** it is the responsibility of the user/installer to verify with tank manufacturer or tank manufacturer supplied documentation that the high limit temperature setting in the preset # used does not exceed the maximum tank exposure temperature. Failure to verify the high limit temperature is below the tank wall maximum exposure temperature can damage the tank.



8 Bartles Corner Road, Unit 104, Flemington, NJ 08822 • 908 788-5210 • Fax 908 788-5204

Appendix D

System Access Code (SAC) Setting Details

System Access Code (SAC) Operating Description

The System Access Code limits the allowable setting limits to prevent unintended potentially harmful settings. The 2XTC Controller ships with the SAC set to 17 which limits allowable settings to prevent damage to polyethylene tanks. Before changing the SAC the user must evaluate the potential issues that could result from allowing higher temperature settings. SAC value of -34 allows high limit settings up to 175°F. Finally a SAC setting of 51 removes all restrictions and allows the full adjustable range of all setting parameters. Exact details of allowable settings for each SAC are shown below.

System Access Code (SAC)		17	-34	51
Menu Parameter	SP Max	100°F	100°F	200°F
	HL SP Max	150°F	175°F	250°F
	Lowest High Limit Offset Setting	0°F	-5°F	-50°F

**Lowering the absolute value of the SAC will adjust settings to be within the requirements of the newly entered SAC.

Caution: *It is the responsibility of the user/installer to verify with tank manufacturer or tank manufacturer supplied documentation that the high limit temperature setting allowed by the SAC setting does not exceed the maximum tank exposure temperature. Failure to verify the allowable high limit temperature is below the tank wall maximum exposure temperature can result in damage the tank.*

Notes:

Notes:

Notes:

SPX210 Quantity	SPX420 Quantity	120 VAC Power Supply			110 VAC Power Supply		
		Heating System Power (W)	Nominal Current (A)	Current Alarm Setting* (A)	Heating System Power (W)	Nominal Current (A)	Current Alarm Setting* (A)
1	0	210	1.8	1.3	176	1.6	1.2
0	1	420	3.5	2.6	353	3.2	2.4
2	0	420	3.5	2.6	353	3.2	2.4
0	1	420	3.5	2.6	353	3.2	2.4
1	1	630	5.3	3.9	529	4.8	3.6
0	2	840	7.0	5.2	706	6.4	4.7
1	2	1050	8.8	6.5	882	8.0	5.9
0	3	1260	10.5	7.8	1058	9.6	7.1
1	3	1470	12.3	9.1	1235	11.2	8.3
0	4	1680	14.0	10.4	1411	12.8	9.5
1	4	1890	15.8	11.7	1588	14.4	10.7
0	5	2100	17.5	13.0	1764	16.0	11.9
1	5	2310	19.3	14.2	1940	17.6	13.1
0	6	2520	21.0	15.5	2117	19.2	14.2

*Suggested alarm settings are based on 10% high heater resistance and 10% low voltage

120 VAC Heaters

SPX-C-640 Quantity	120 VAC Power Supply			110 VAC Power Supply		
	Heating System Power (W)	Nominal Current (A)	Current Alarm Setting* (A)	Heating System Power (W)	Nominal Current (A)	Current Alarm Setting* (A)
1	640	5.3	3.9	538	4.9	3.6
2	1280	10.7	7.9	1075	9.8	7.2
3	1920	16.0	11.8	1613	14.7	10.8
4	2560	21.3	15.8	2150	19.5	14.5
5	3200	26.7	19.7	2688	24.4	18.1

*Suggested alarm settings are based on 10% high heater resistance and 10% low voltage

240 VAC Heaters

SPX-C-640 Quantity	240 VAC Power Supply			220 VAC Power Supply			208 VAC Power Supply		
	Heating System Power (W)	Nominal Current (A)	Current Alarm Setting* (A)	Heating System Power (W)	Nominal Current (A)	Current Alarm Setting* (A)	Heating System Power (W)	Nominal Current (A)	Current Alarm Setting* (A)
1	640	2.7	2.0	538	2.4	1.8	480	2.3	1.7
2	1280	5.3	3.9	1075	4.9	3.6	960	4.6	3.4
3	1920	8.0	5.9	1613	7.3	5.4	1440	6.9	5.1
4	2560	10.7	7.9	2150	9.8	7.2	1920	9.2	6.8
5	3200	13.3	9.9	2688	12.2	9.0	2400	11.5	8.5
6	3840	16.0	11.8	3226	14.7	10.8	2880	13.8	10.2

*Suggested alarm settings are based on 10% high heater resistance and 10% low voltage

120 VAC Heaters

EGLX500-120 Quantity	120 VAC Power Supply			110 VAC Power Supply		
	Heating System Power (W)	Nominal Current (A)	Current Alarm Setting (A)	Heating System Power (W)	Nominal Current (A)	Current Alarm Setting (A)
1	500	4.2	3.1	420	3.8	2.8
2	1000	8.3	6.2	840	7.6	5.7
3	1500	12.5	9.3	1260	11.5	8.5
4	2000	16.7	12.3	1680	15.3	11.3
5	2500	20.8	15.4	2100	19.1	14.1
6	3000	25.0	18.5	2520	22.9	17.0

*Suggested alarm settings are based on 10% high heater resistance and 10% low voltage

240 VAC Heaters

EGLX500-240 Quantity	240 VAC Power Supply			220 VAC Power Supply			208 VAC Power Supply		
	Heating System Power (W)	Nominal Current (A)	Current Alarm Setting (A)	Heating System Power (W)	Nominal Current (A)	Current Alarm Setting (A)	Heating System Power (W)	Nominal Current (A)	Current Alarm Setting (A)
1	500	2.1	1.5	420	1.9	1.4	375	1.8	1.3
2	1000	4.2	3.1	840	3.8	2.8	750	3.6	2.7
3	1500	6.3	4.6	1260	5.7	4.2	1125	5.4	4.0
4	2000	8.3	6.2	1680	7.6	5.7	1500	7.2	5.3
5	2500	10.4	7.7	2100	9.5	7.1	1875	9.0	6.7
6	3000	12.5	9.3	2520	11.5	8.5	2250	10.8	8.0

*Suggested alarm settings are based on 10% high heater resistance and 10% low voltage

120 VAC Heaters

EGLX400-120	120 VAC Power Supply			110 VAC Power Supply		
	Heating System Power (W)	Nominal Current (A)	Current Alarm Setting (A)	Heating System Power (W)	Nominal Current (A)	Current Alarm Setting (A)
1	400	3.3	2.5	336	3.1	2.3
2	800	6.7	4.9	672	6.1	4.5
3	1200	10.0	7.4	1008	9.2	6.8
4	1600	13.3	9.9	1344	12.2	9.0
5	2000	16.7	12.3	1680	15.3	11.3
6	2400	20.0	14.8	2016	18.3	13.6

*Suggested alarm settings are based on 10% high heater resistance and 10% low voltage

240 VAC Heaters

EGLX400-240	240 VAC Power Supply			220 VAC Power Supply			208 VAC Power Supply		
	Heating System Power (W)	Nominal Current (A)	Current Alarm Setting (A)	Heating System Power (W)	Nominal Current (A)	Current Alarm Setting (A)	Heating System Power (W)	Nominal Current (A)	Current Alarm Setting (A)
1	400	1.7	1.2	336	1.5	1.1	300	1.4	1.1
2	800	3.3	2.5	672	3.1	2.3	600	2.9	2.1
3	1200	5.0	3.7	1008	4.6	3.4	900	4.3	3.2
4	1600	6.7	4.9	1344	6.1	4.5	1200	5.8	4.3
5	2000	8.3	6.2	1680	7.6	5.7	1500	7.2	5.3
6	2400	10.0	7.4	2016	9.2	6.8	1800	8.7	6.4

*Suggested alarm settings are based on 10% high heater resistance and 10% low voltage

240 VAC Heaters on 277 VAC

EGLX400-240	277 VAC Power Supply		
	Heating System Power (W)	Nominal Current (A)	Current Alarm Setting (A)
1	532	1.9	1.4
2	1064	3.8	2.8
3	1596	5.8	4.3
4	2128	7.7	5.7
5	2660	9.6	7.1
6	3192	11.5	8.5

*Suggested alarm settings are based on 10% high heater resistance and 10% low voltage

2XTC

Microprocessor Based Tank Heating Controller



The 2XTC Tank Heating Controller is the most complete and versatile tank heating controller in existence. Use this product to accurately control SPX and EGLX tank heating pads as well as WinterSafe Self-Regulating Heating Cable.

PRODUCT FEATURES

- Process temperature control with hi-limit protection
- 100-277 VAC, 50/60 HZ, 30A
- Use with up to 6 heaters
- Push-on heater connections for a quick installation
- Simple operation and customizable preset
- High temperature, low temperature, and low current alarms
- Alarm contact for communication with customer systems (NO or NC, selectable)
- NEMA4X, IP66, polycarbonate enclosure
- 4-20mA retransmission output
- Includes two RTDs
- cETLus approved for use in the USA and Canada

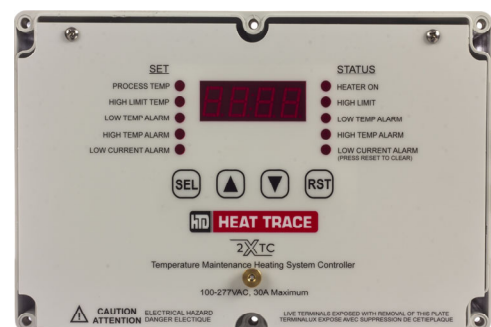

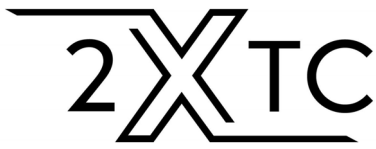

Description

The HTD Heat Trace 2XTC Temperature Maintenance Heating System Controller is specifically designed for heating systems requiring process temperature control with high limit temperature protection. The most common tank heating applications using process and high limit control are non-metallic tanks, lined tanks or tanks with heat sensitive contents. This controller is designed for use with SPX heating pads, EGLX heating panels, heating cable and any other electric trace heater. The 2XTC controller is provided in a NEMA4X/IP66 polycarbonate enclosure for use indoors or outdoors

The 2XTC controller can be used on power supplies from 100 to 277 VAC for maximum versatility. The controller switches up to a 30A heating load using active arc suppression for maximum relay contact life.

The controller provides indication of process sensor temperature, over limit sensor temperature and heater current using a simple main setting menu. Indication is provided using high visibility LED number indication as well as LED lights showing set values and system status.

The 2XTC controller provides alarm and system status for use with remote monitoring such as DCS or SCADA systems. Alarms are provided for low temperature, high, temperature and low current alarm. These alarms are indicated by lights on the front of the controller and relay contacts for remote indication. Alarm relay contacts are selectable for close or open on alarm. In addition the controller offers current interval testing to periodically test for correct heating current. The current alarm can be set to off if not desired or test frequencies of 24, 168 or 720 hours. A 4-20 mA retransmission output is also provided for remote indication of the process temperature.

Technical Specifications

General

Power Input:	100-277 VAC, 50/60HZ, 30 Amps maximum
Operating Temperature:	-40°F to 113°F (-40 to 45°C)
Process Control:	On/Off with adjustable hysteresis
Process Control Output:	SPST NO Relay rated 30 Amps at 277 VAC with active arc suppression

Setting Range

Process Temperature:	0-200°F
High Limit Temperature:	0-250°F
Low Temperature Alarm:	0-200°F
High Temperature Alarm:	0-200°F
Low Current Alarm:	OFF or 0.5 to 30 Amps

Alarm and System Status

Alarms:	Low Temperature, High Temperature and Low Current
Alarm Indication:	LEDs on the controller face
Alarm Outputs:	SPST Relays rated 5 A at 277 VAC/5A at 30 VDC
Alarm Output Type:	Relay contact Selectable open or close alarm
Retransmission Output:	4-20 mA indication of process temperature with selectable span

Sensor Input

Sensor Type:	1KΩ Platinum RTD, 2 wire
Sensor α:	0.00385

Approval



UL 508

CSA 22.2 #14

2XTC Manual

